

RECOMMENDED PCB LAYOUT
TOLERANCE: + / - 0.03

PIN.NO.	A	B	C	D	E	F	G
10	5.50	4.70	2.80	3.20	4.10	2.47	2.00
14	6.50	5.70	3.80	4.20	5.10	3.47	3.00

- NOTES:
1. DIMENSION SHALL BE INTERPRETED PER ASME Y14.5M-1994.
 2. ELECTRICAL CHARACTERISTICS
 - 2.1 RATED CURRENT: 0.5A MAX.;
 - 2.2 CONTACT RESISTANCE: 50 MOHMS MAX.;
 - 2.3 INSULATION RESISTANCE: 500 MOHMS MIN.;
 - 2.4 WITHSTANDING VOLTAGE: 150 VAC FOR 1 MINUTE MIN.;
 3. MECHANICAL CHARACTERISTICS
 - 3.1 DURABILITY: 50 CYCLES
 - 3.2 VIBRATION: PASSED MIL-STD-202F METHOD 201.
 - 3.3 SHOCK: PASSED MIL-STD-202F METHOD 107D, CONDITION A.
 4. ENVIRONMENT CHARACTERISTICS
 - OPERATION TEMPERATURE RANGE: -40°C TO +85°C.
 5. LEAD FREE AND ROHS AND HALOGEN FREE COMPLIANT.

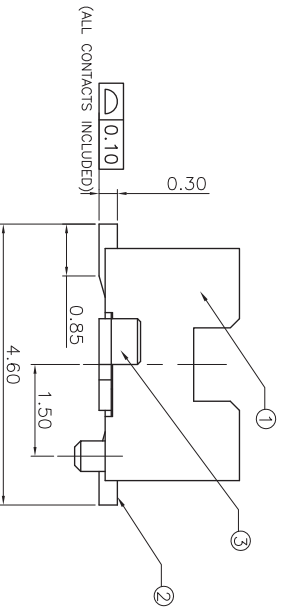
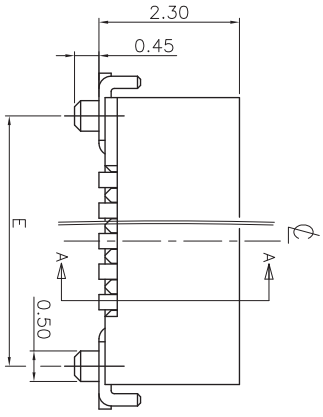

(ALL CONTACTS INCLUDED)

BT 5 P 0 ** 1-1 00 1 H
 5: 0.50PITCH
 P: PLUG.
 POS NO: 010=10 POS
 014=14 POS.
 HALOGEN FREE
 PACKAGE CODE:
 1: TAPE REEL
 PROFILE HEIGHT
 1:H=2.5mm

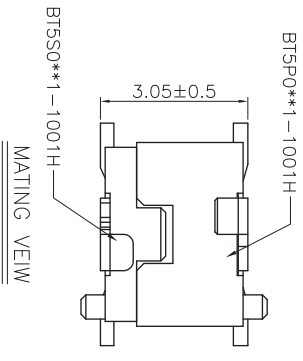

MATING VIEW

SECTION A-A

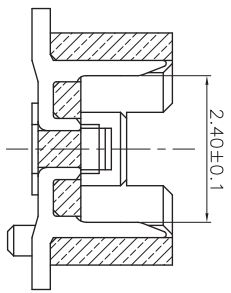

Q'TY	NAME	MATERIAL	FINISH	ITEM NO.
2	PAD	COPPER ALLOY	MATTETIN PLATING ALL AROUND, ALL OVER NICKEL UNDERPLATED	③
**	CONTACT	COPPER ALLOY	50u" MIN. NICKEL UNDER PLATING; 5u" GOLD PLATING ON CONTACT AREA; 1u" GOLD PLATING ON CONTACT AREA;	②
1	HOUSING	HIGHTEMP-PLASTIC	UL94V-0, WHITE	①

UNITS:	GENERAL TOLERANCE	APPROVE:	PART NO.(INTENDED USE)
mm		Fan Fang	BT550**1-1001H

DATE:	X:	X:	±2.00"
10/12/13	.X	±0.20	.X' ±1.50"

SCALE:	.XX	±0.15	.XX' ±1.00"
N/A	N/A	N/A	N/A

SHEET:	MATERIAL:	Q'TY	DRAW:	DRAWING NO.:
1/2			Cathy Yi	820-0000-011



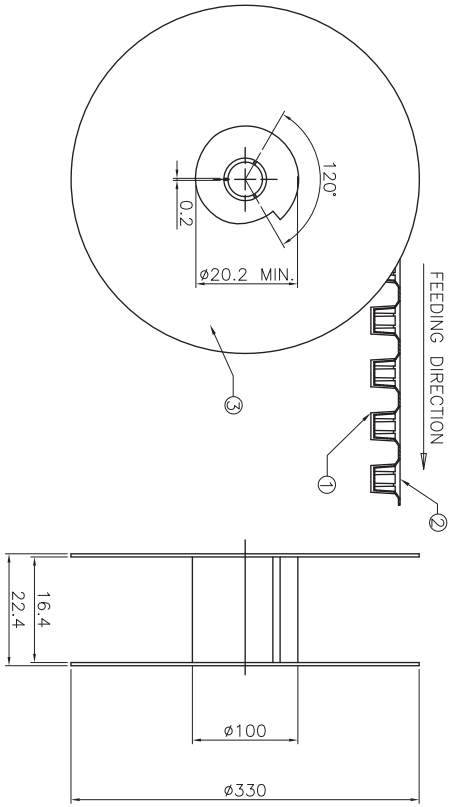

NOTES:

1. 10 PITCHES CUMULATIVE TOLERANCE ON TAPE $\pm 0.20\text{mm}$.
2. COVER TAPE PEELING STRENGTH: 0.13Kgf/ MAX AT 300mm/MINUTE.

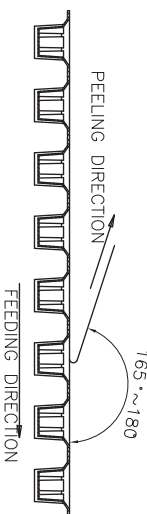

3. PACKING CAPACITY:

P/N	PCS/REEL	REEL/BOX	PCS/BOX
BTSP0101-1001H	1500	10	15000
BTSP0141-1001H	1500	10	15000

Digitized by GJC
DCC ISSUE
2015.10.28
文管发行

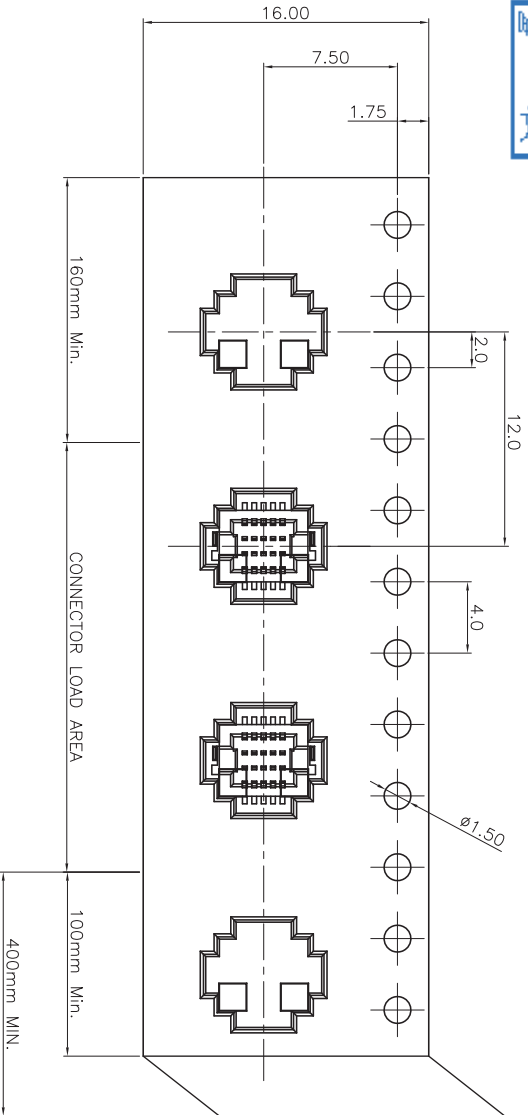

UNITS:

mm

GENERAL TOLERANCE

DATE:	SCALE:	SHEET:	REV.:
10/12/13	N/A	2/2	D

DATE:	SCALE:	SHEET:	REV.:
10/12/13	N/A	2/2	D

DATE:	SCALE:	SHEET:	REV.:
10/12/13	N/A	2/2	D

ITEM	DESCRIPTION	MATERIAL
③	REEL	POLYSTYRENE
②	COVER TAPE	POLYESTER
①	CARRIER TAPE	POLYSTYRENE

APPROVE: Fan Fang

CHECKED: Walker Zhao

DRAW: Cathy Yi

PART NO.(INTENDED USE)
BTSP0**1-1001H

TITLE: 0.5P PLUG BTB

DRAWING NO.: 820-0000-011



Dragho ELECTRONICS TECHNOLOGY CO., LTD
Highstar